

X1202

Contents

SAFETY INSTRUCTIONS AND WARNINGS

Overview

Features

Packing List

User Manual

Matching Case

FAQ

SAFETY INSTRUCTIONS AND WARNINGS

- You must read these safety instructions and warnings before charging your batteries.
- Lithium Polymer and Li-ion batteries are volatile. Failure to read and follow the below instructions may result in fire, personal injury and damage to property if charged or used improperly.
- Never make wrong polarity connection when charging and discharging battery packs. Always double check polarity of battery's connector to make sure "+" to "+" and "-" to "-".
- Do not mix and use old batteries and new batteries, or batteries with different brand names.
- Lithium batteries has it's cycle life, please replace old battery with new one when it reaches it's service life or when it is two year old, whichever comes first.
- When charging Battery Pack, please put battery in a fire proof container. Please don't leave the X1202 on the wood material or carpet and unattended.

Overview

This X1202 is an ultra-compact advanced uninterruptible power supply expansion board designed specifically for the Raspberry Pi 5. With its advanced features and robust power backup capabilities, the X1202 is perfect for even the most demanding Raspberry Pi setups.



- 1 DC6-18V input DC jack 5.5x2.1mm
- 2 DC6-18V input XH2.54-2P connector
- 3 USB-C power Input 5Vdc 5A
- 4 CHG - Charging LED
Flashing: battery charging
Solid on: battery fully charged
Off: charging disabled
- 5 Pi5 Detection LED
Solid on: Pi power on
Off: Pi shut down
- 6 5V0 - 5V Power output LED
On: Power on
Off: Power off
If the Pi5 is not detected, will turn on for 3 seconds then off
- 7 Battery voltage level indicators
- 8 Power Button
1. Perform the same function as the Pi5 power button
2. Press the button thrice in quick succession to turn off the UPS
- 9 XH2.54-2P connector for external momentary power button
- 10 USB power output 5V, current unlimited
- 11 5V power output XH2.54-2P x2
- 12 18650 Battery Holder x4
Battery length max 65.3mm, diameter max 18.5mm.

Interface

Model	Compatible with	Position	Battery Holder NO.	How to Power	Note	Matching Case
X1200	Raspberry Pi 5	Bottom	2-Cell	5Vdc 5A via USB Type-C of X1200	-	X1200-C1
X1201	Raspberry Pi 5	Bottom	2-Cell	5Vdc 5A via USB Type-C of X1201	Ultra-thin	X1201-C1
X1202	Raspberry Pi 5	Bottom	4-Cell	5Vdc 5A via USB Type-C of X1202; or 6-18Vdc , $\geq 3A$ via DC 5521 power jack of X1202	-	X1202-C1
X1203	Raspberry Pi 5	Bottom	without battery holder	5Vdc 5A via USB Type-C of X1203; or 6-18Vdc , $\geq 3A$ via DC 5521 power jack of X1203	-	-



X1202 front view

Reliable Power Backup: The X1202 provides a stable 5.1V 5000mA power backup, ensuring uninterrupted operation of your Raspberry Pi. Whether you are running resource-intensive applications or powering multiple peripherals, the X1202 delivers reliable and consistent power supply.

Enhanced Power Management: One of the standout features of the X1202 is its enhanced power management system. It intelligently monitors the power status of the Raspberry Pi and automatically cuts off power when the Pi is shut down. This helps optimize battery life by entering an ultra-low standby power consumption mode. It ensures efficient operation and maximizes the lifespan of the UPS battery.

Seamless Power Switching: Equipped with AC power loss and power adapter failure detection, the X1202 seamlessly switches to backup power in the event of a power outage or power adapter failure. This feature guarantees that your Raspberry Pi remains operational and protected from unexpected power disruptions.

Convenient Features: The X1202 offers convenient features such as auto power-on, enabling your Raspberry Pi to automatically boot up when power is restored. It also supports full power-off from software, allowing you to safely shut down your Raspberry Pi without manual intervention.

Fast Charging: With fast charging capabilities of up to 3000mA, the X1202 ensures quick recharging of the UPS, making it ready to provide backup power whenever needed.

Versatile Design: The X1202 is designed to be attached on bottom and don't use the 40-pin header, enabling easy stacking with other Raspberry Pi accessory

boards. This versatility allows you to expand the functionality of your Raspberry Pi and create enhanced applications tailored to your specific needs.

Seamless Data Backup: The X1202 is compatible with our range of storage products, providing seamless integration for safe and reliable data backup. Your valuable data remains protected, even in the event of a power failure.

Enhance the reliability and performance of your Raspberry Pi 5B with the X1202 UPS expansion board. Experience peace of mind with its advanced features and robust power backup capabilities. Trust the X1202 to ensure uninterrupted operation and safeguard your valuable data.

Features



X1202 back view

For use with	Raspberry Pi 5
Key Features	<p>UPS Output</p> <ul style="list-style-type: none"> ▪ Provides continuous operation for up to 10 hours (duration depends on battery type and applications) ▪ Supports a maximum current output of 5.1V 5000mA, suitable for most Raspberry Pi applications ▪ Integrated Advanced Power MOSFET with an equivalent of 7mΩ RDS(ON) to minimize power loss ▪ Convenient pogo pin connection for powering the Pi, eliminating the need for cabling and soldering ▪ Equipped with XH2.54 connectors and two USB sockets for 5V power output <p>Battery Charging</p> <ul style="list-style-type: none"> ▪ Supports fast battery charging with a capacity of 3000mA ▪ Battery charging control can be managed via GPIO ▪ Provides protection against battery overcurrent and overvoltage ▪ Built-in protection against reverse connection of battery cells ▪ Integrated Maxim's fuel-gauge systems for reading battery voltage and percentage over i2c ▪ On-board LEDs indicate battery charging and discharging levels of 25%, 50%, 75%, and 100% ▪ Features a 4-cell 18650 battery holder <p>Power Input</p> <ul style="list-style-type: none"> ▪ Integrated high-efficiency step-down DC-DC converter ▪ Wide operating input range of 6V to 18V ▪ Up to 95% efficiency for optimal power conversion ▪ Provides up to 5.5A output current, enabling 3A fast charging while powering the system ▪ Allows power input from various sources such as a car, solder panel, and more ▪ Common power input jack size of 5.5x2.1mm ▪ Compatible with Raspberry Pi USB-C Power Supply <p>Power Management</p>

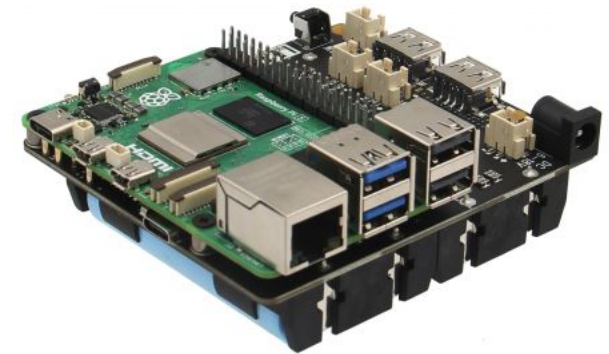

X1202 Use

- Seamless power switching between backup power and power adapter
- On-board push button performs the same actions as the Pi's power button
- Automatically cuts off power when the Pi is shut down
- On-board LED indicates power status and Pi detection
- AC power loss and power adapter failure detection via GPIO
- Auto power-on when power is applied or restored
- Automatic safe shutdown when battery voltage is low (programmable)
- Ultra-low standby power consumption to maximize battery life
- Advanced system power-path management to minimize frequent charging and discharging of batteries

Misc

- Connects to the Pi via convenient pogo pins, eliminating the need for additional cabling
- Designed to be attached on the bottom, allowing the use of favorite HATs alongside it
- XH2.54 connector available for adding your own power button



X1202 with Active cooler

Spec

Power input: 6-18Vdc,(12Vdc 3A power adapter recommended)

UPS output: 5.1V \pm 5% Max 5A

Battery charging current: Max 2.3-3.2A

Terminal Battery Voltage: 4.23V

Battery Recharge Threshold: 4.1V

Ports & Connectors:

- DC power jack - 5.5x2.1mm
- DC6-18V power input connector x1 - XH2.54-2P
- USB Type-C socket x1
- 18650 battery socket x4
- 5V Power output connector x2 - XH2.54 2-pin
- USB2.0 type-A power output socket x2
- External power button connector x1 - XH2.54-2P

	PCB Size: 97.4mm x 85mm
Power Supply Tips	<ul style="list-style-type: none">▪ 1. The Wide 6-18V Input allows the user to choose the power supply flexibly. The required current is greater than or equal to 2A/3A.▪ 2. The reserved 6-18V XH2.54 connector provide convenient power supply when integrate X1202 with other products.▪ 3. The X1202's Type-C port simplifies power supply by supporting the 5V 5A Type-C power adapter used by the Raspberry Pi 5.
Notes	<ul style="list-style-type: none">▪ Do not apply power to your Raspberry Pi 5 via the Type-C USB socket.▪ Do not use 18650 battery with built-in protection circuit.

Packing List

- 1 x X1202 UPS Shield
- 4 x CM2.5*4 screws

X1202 Packing List



User Manual

- Dimensions source file (DXF): [File:X1202-pcb.dxf](#) - You can view it with [Autodesk Viewer \(https://viewer.autodesk.com/\)](https://viewer.autodesk.com/) online
- X1202 Hardware: [X1202 Hardware](#)

- How to get x1202 work: X1202 Software (https://suptronics.com/Raspberrypi/Power_mgmt/x120x-v1.0_software.html)
- Installation Guide

1

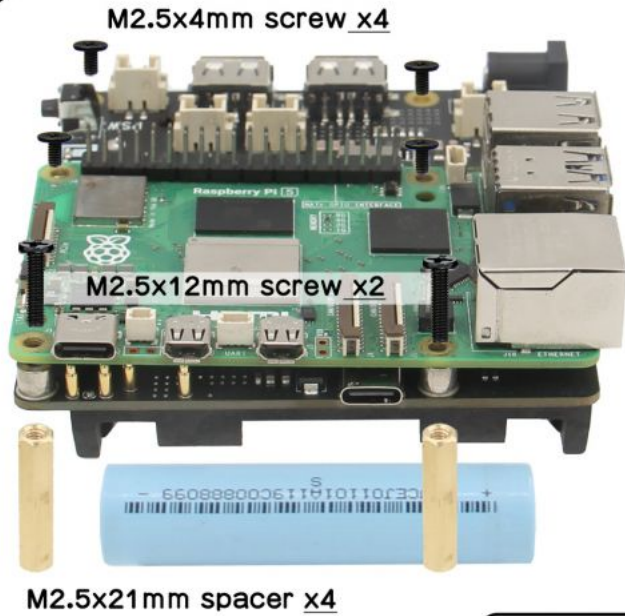

2 (Optional Step)

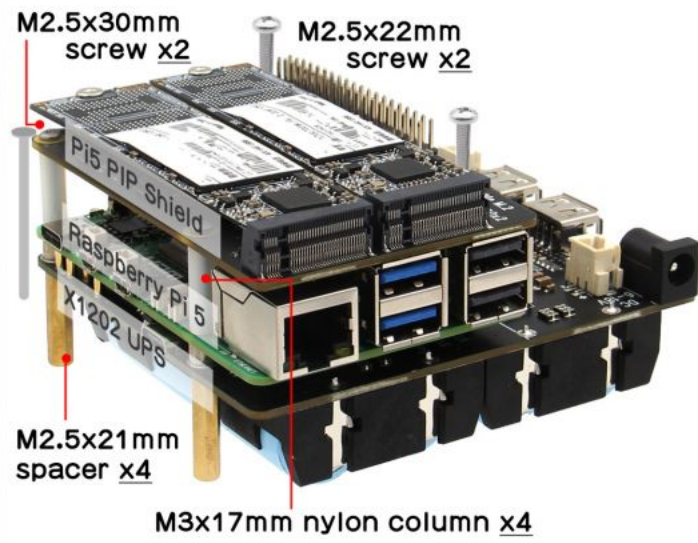

Installation Guide

3



4



Installation Video https://youtu.be/Iof_DLOfSU8



Matching Case

X1202-C1 case is designed for the raspberry pi 5 & X1202 ups shield only, also with space reserved on the top for mounting the Raspberry Pi 5 PIP boards, such as the X1001, X1004, X1003, X1000 and M901.

- Case dimensions: 100 x 90.8 x 62.8 mm / 3.94 x 3.57 x 2.47 inches

X1202-C1 Packing List



 Rubber Pads	 M2.5x21mm	 M2.5x12mm	 ø3x17mm	 M2.5x22mm	 M2.5x30mm
--	---	---	---	---	--

For Raspberry Pi 5 & X1202 UPS Shield

Support active cooler / TOP Raspberry Pi 5 PIP Shield (NOT included)

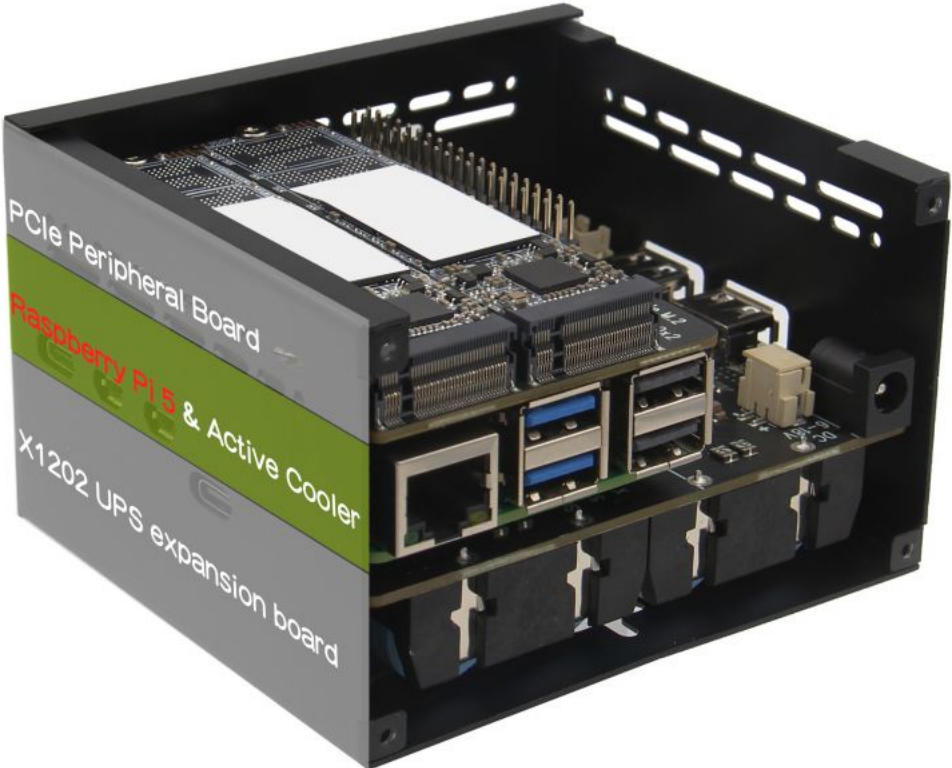

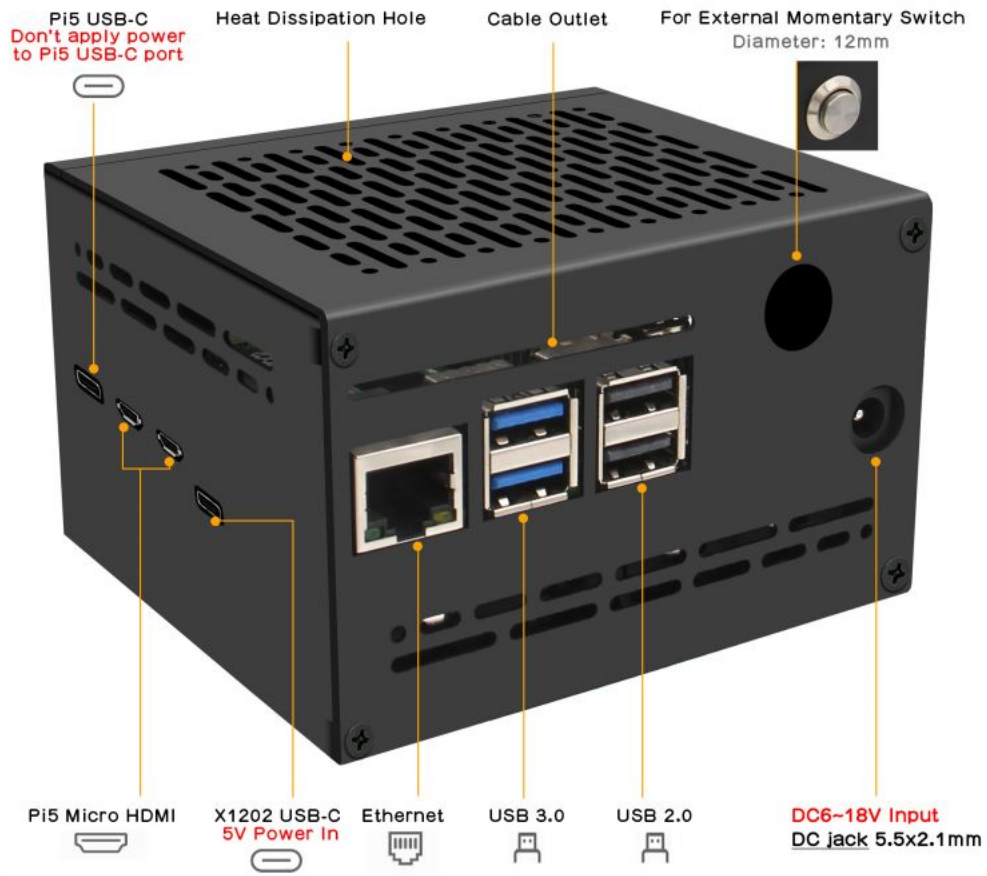

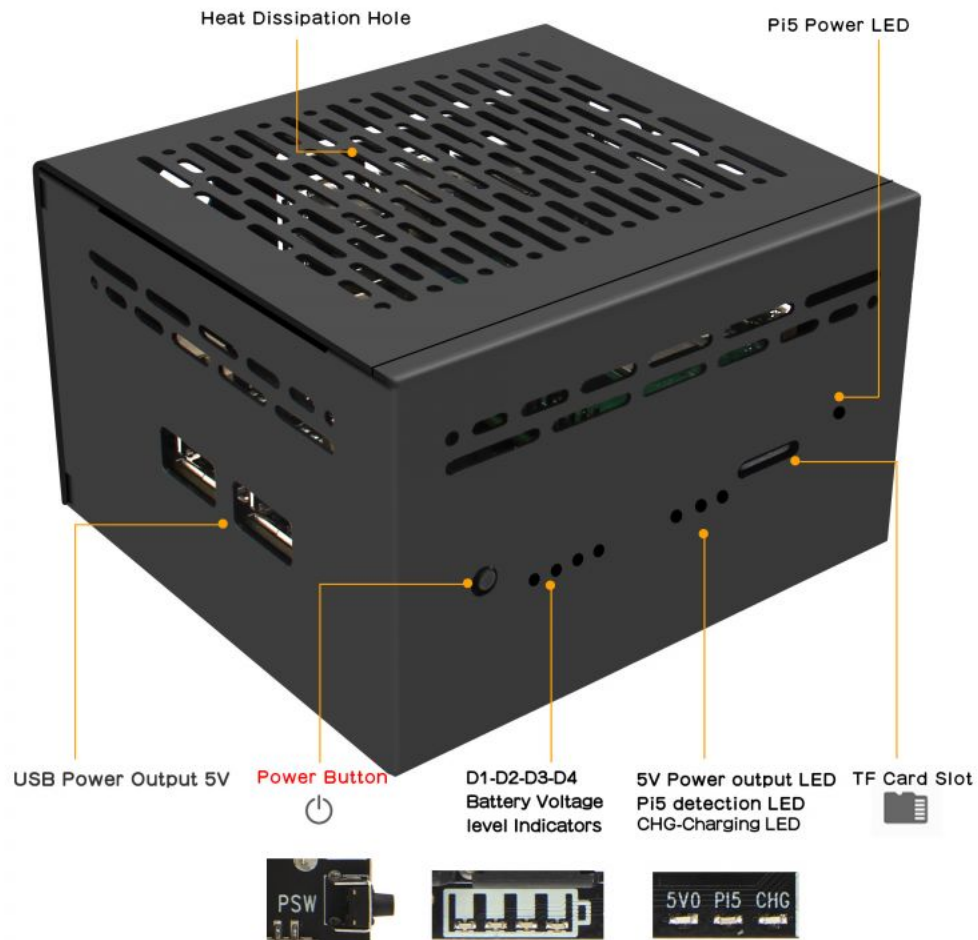

FAQ

Q: Why does the message "This power supply is not capable of supplying 5A" appear??

X120X series UPS shield can provide **enough 5A** power supply capacity;

Please set as follows:

Open the Terminal window based on **Raspberry Pi OS** and execute the following command:

```
sudo rpi-eeeprom-config -e
```

Add `PSU_MAX_CURRENT=5000` at the end of the file that reads like this:

```
GNU nano 7.2 /tmp/tmppr8na3qw/boot.conf
[all]
BOOT_UART=1
POWER_OFF_ON_HALT=0
BOOT_ORDER=0xf461
PSU_MAX_CURRENT=5000
```

Press **Ctrl-O**, then enter, to write the change to the file.

Press **Ctrl-X** to exit nano (the editor).

Reboot your Raspberry Pi 5 to make the change take effect.

Note: If you are using other OS like Ubuntu, please flash **Raspberry Pi OS** first, and then re-flash other OS such as Ubuntu etc after completing the above settings.

Q: How to disable auto power on feature on X1200?

A: When you connect an external power supply, the UPS board will automatically power on the Pi 5 motherboard while it starts charging, this feature is called **auto power on**, considering that some customers need to disable this feature, so we have also disclosed the following solution to disable it: please use a soldering iron to remove the resistor indicated by the arrow in the illustration.

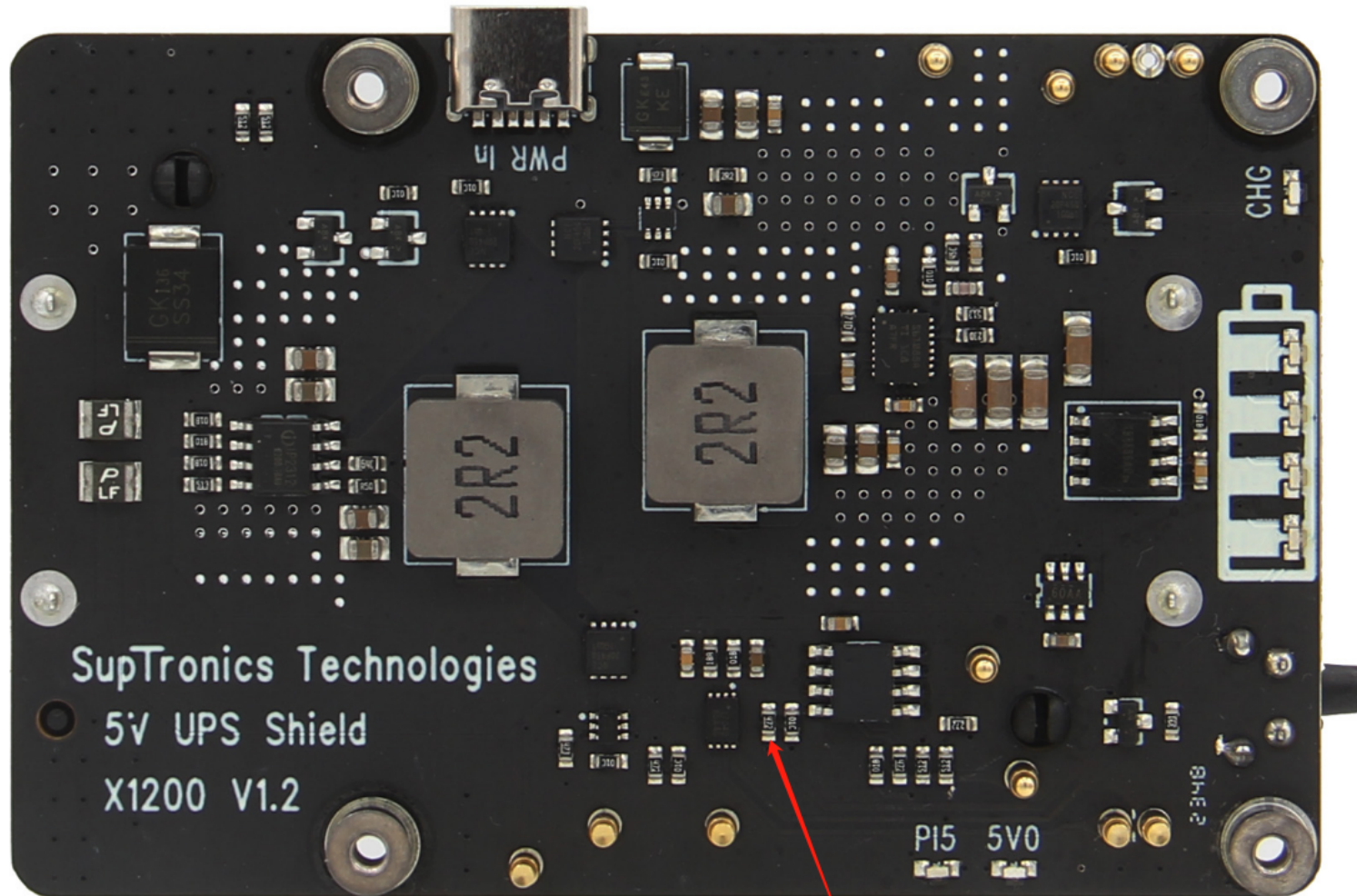

WARNING: Please consider the following risks before removing this resistor:

- Do not operate if you are not a professional user
- The removal operation may damage the MCU, so please be careful with the operation.
- Once you remove this resistor by yourself, you will **lose the warranty** of this product. We no longer offer any warranty for this product.
- Once you remove this resistor, you can only turn on the power output by pressing the on-board switch.

Q: How to disable auto power on feature on X1201?

A: When you connect an external power supply, the UPS board will automatically power on the Pi 5 motherboard while it starts charging, this feature is called **auto power on**, considering that some customers need to disable this feature, so we have also disclosed the following solution to disable it: please use a soldering iron to remove the resistor indicated by the arrow in the illustration.

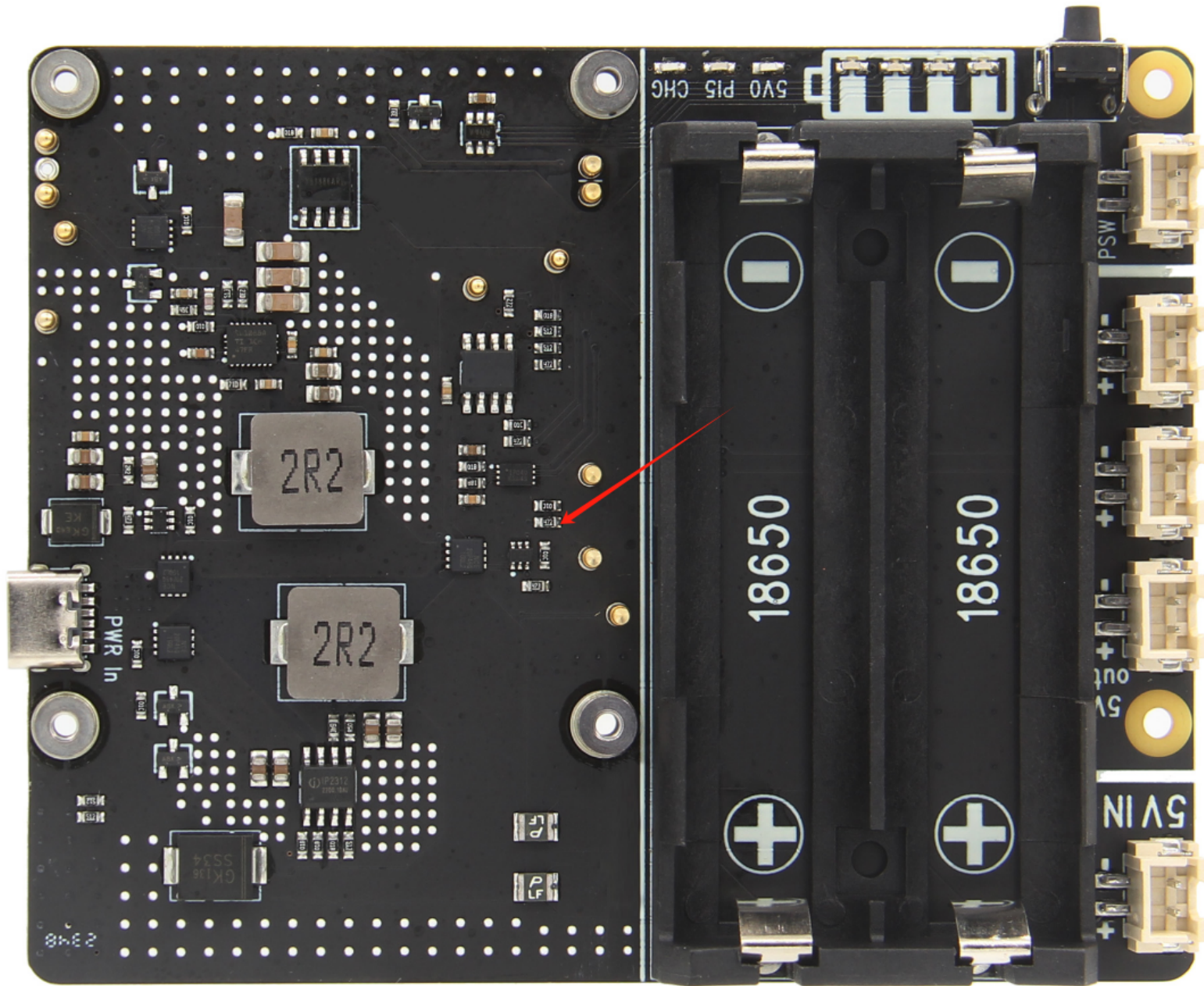

WARNING: Please consider the following risks before removing this resistor:

- Do not operate if you are not a professional user

- The removal operation may damage the MCU, so please be careful with the operation.
- Once you remove this resistor by yourself, you will lose the warranty of this product. We no longer offer any warranty for this product.
- Once you remove this resistor, you can only turn on the power output by pressing the on-board switch.

Q: How to disable auto power on feature on X1202?

[Collapse]

A: When you connect an external power supply, the UPS board will automatically power on the Pi 5 motherboard while it starts charging, this feature is called **auto power on**, considering that some customers need to disable this feature, so we have also disclosed the following solution to disable it: please use a soldering iron to remove the resistor indicated by the arrow in the illustration.

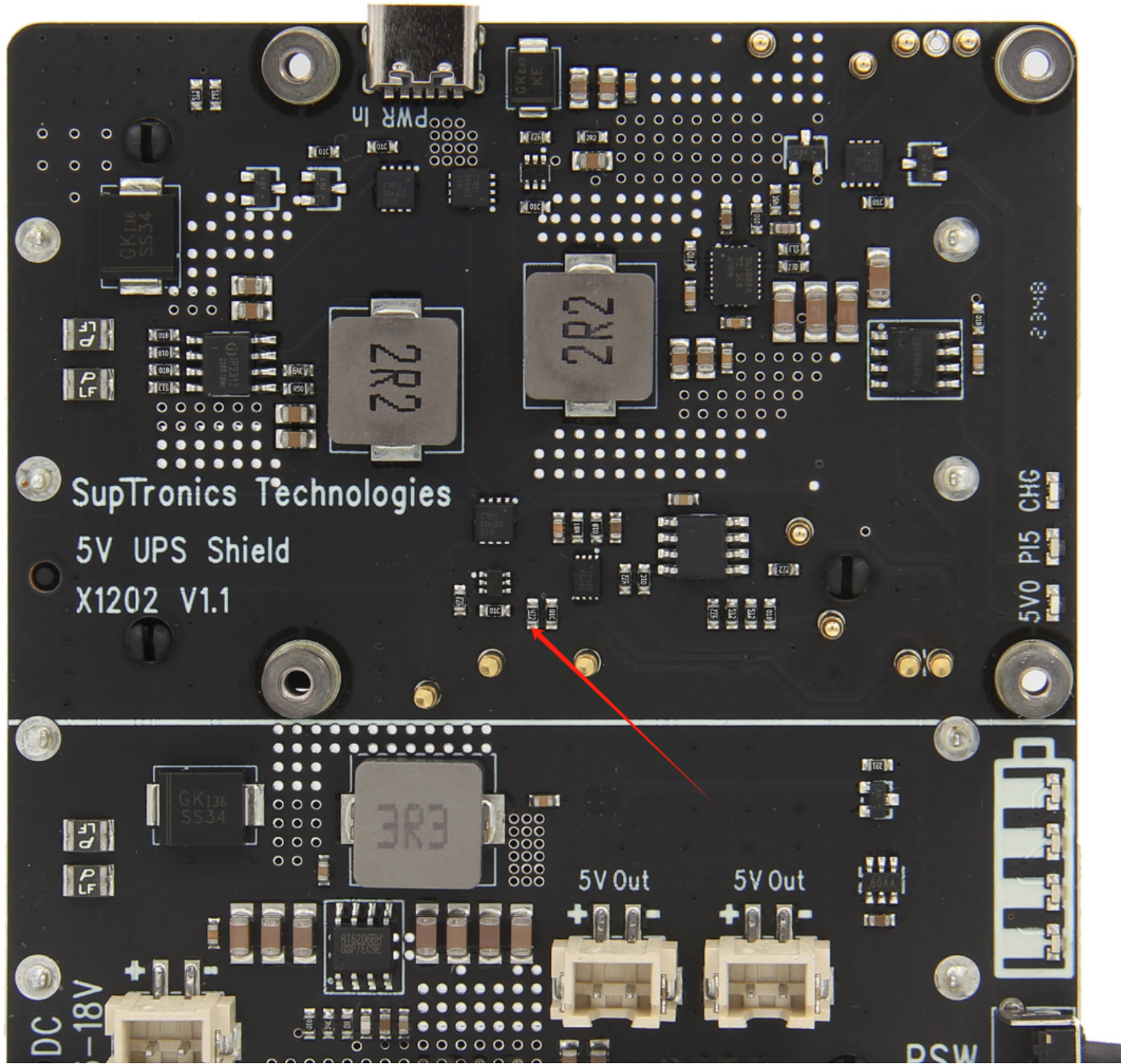

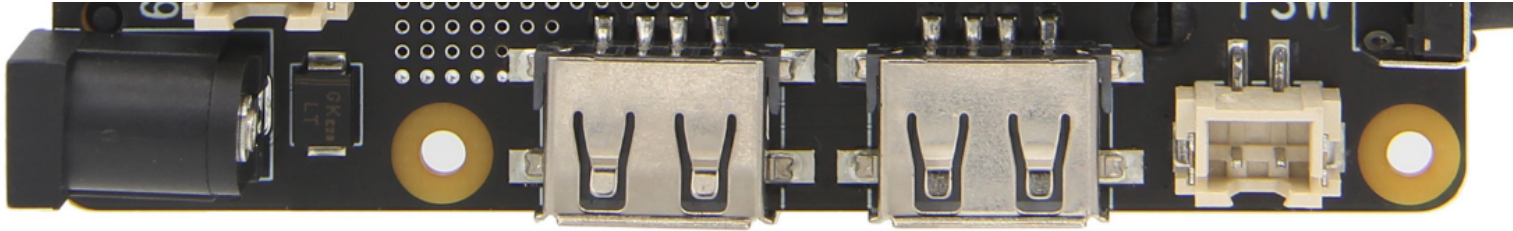

WARNING: Please consider the following risks before removing this resistor:

- Do not operate if you are not a professional user
- The removal operation may damage the MCU, so please be careful with the operation.
- Once you remove this resistor by yourself, you will lose the warranty of this product. We no longer offer any warranty for this product.
- Once you remove this resistor, you can only turn on the power output by pressing the on-board switch or external power switch.

Q: Why does the UPS shield continue to output power when PI 5 is turned off via press the on-board button?

[Collapse]

A: The UPS shield provides enhanced power management features that intelligently monitor the power status of the Raspberry Pi 5 and automatically cut off power when the Pi is powered off. This helps optimize battery life by entering an ultra-low standby power consumption mode. It ensures efficient operation and maximizes the lifespan of the UPS battery.

To get the above features, check that the following settings are complete

This tutorial assumes you've already set up a Raspberry Pi with Raspbian12(bookworm). For help installing the Debian-based OS on your Pi, check out the docs on Raspberrypi.org.

1.0 Editing the EEPROM configuration

1.1 From the command line or Terminal window start by running the following command :

```
pi@raspberrypi ~ $ sudo rpi-eeprom-config -e
```

Change the setting of **POWER_OFF_ON_HALT** from **0** to **1** ,

Add **PSU_MAX_CURRENT=5000** at the end of the file that reads like this:

```
GNU nano 7.2 /tmp/tmpf9i3trrp/boot.conf
[all]
BOOT_UART=1
POWER_OFF_ON_HALT=1
BOOT_ORDER=0xf41
PSU_MAX_CURRENT=5000
```

1.2 Reboot your Raspberry Pi 5 to make the change take effect.

```
pi@raspberrypi ~ $ sudo reboot
```

Q: What battery is recommended for this ups shield

[Collapse]

A: Please use high quality batteries from Samsung 35E 18650 lithium battery, PANPASONIC, Toshiba, etc. Do not use the battery with built-in protection circuit.

For the X1203 shield:

If using a lithium battery, the required voltage is 3.7V;

if using a battery pack, please make sure it is a parallel battery pack.

There are 2 XH2.54-2P battery connectors on board, it is recommended to use the same type of battery.

18650 Battery Size

Max. 18.5 mm

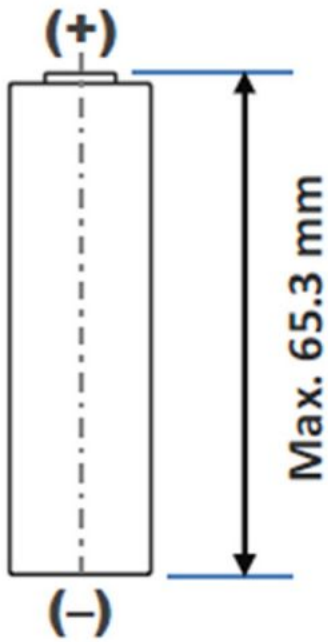
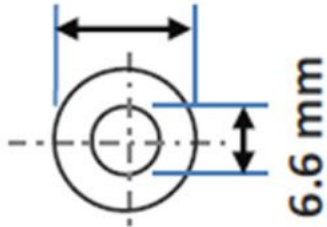

┌──────────────────┬──────────────────┐
└──────────────────┘──────────────────┘

Note: Batteries are not included in the packing list.

Q: Run `sudo i2cdetect -y 1`, can't find I2C address 0x36?

[Collapse]

A:

1. Make sure you enable i2c interface, refer to [How to enable I2C](#)
2. The UPS connects to the Pi GPIO via pogo pins, If the I2C address (0x36) is not detected, Please clear the leads of pin 3 and pin 5 on the GPIO header from the bottom of the Raspberry Pi PCB and install again, and also check if the pogo pin of ups shield is in close contact with the pad position of PI 5.

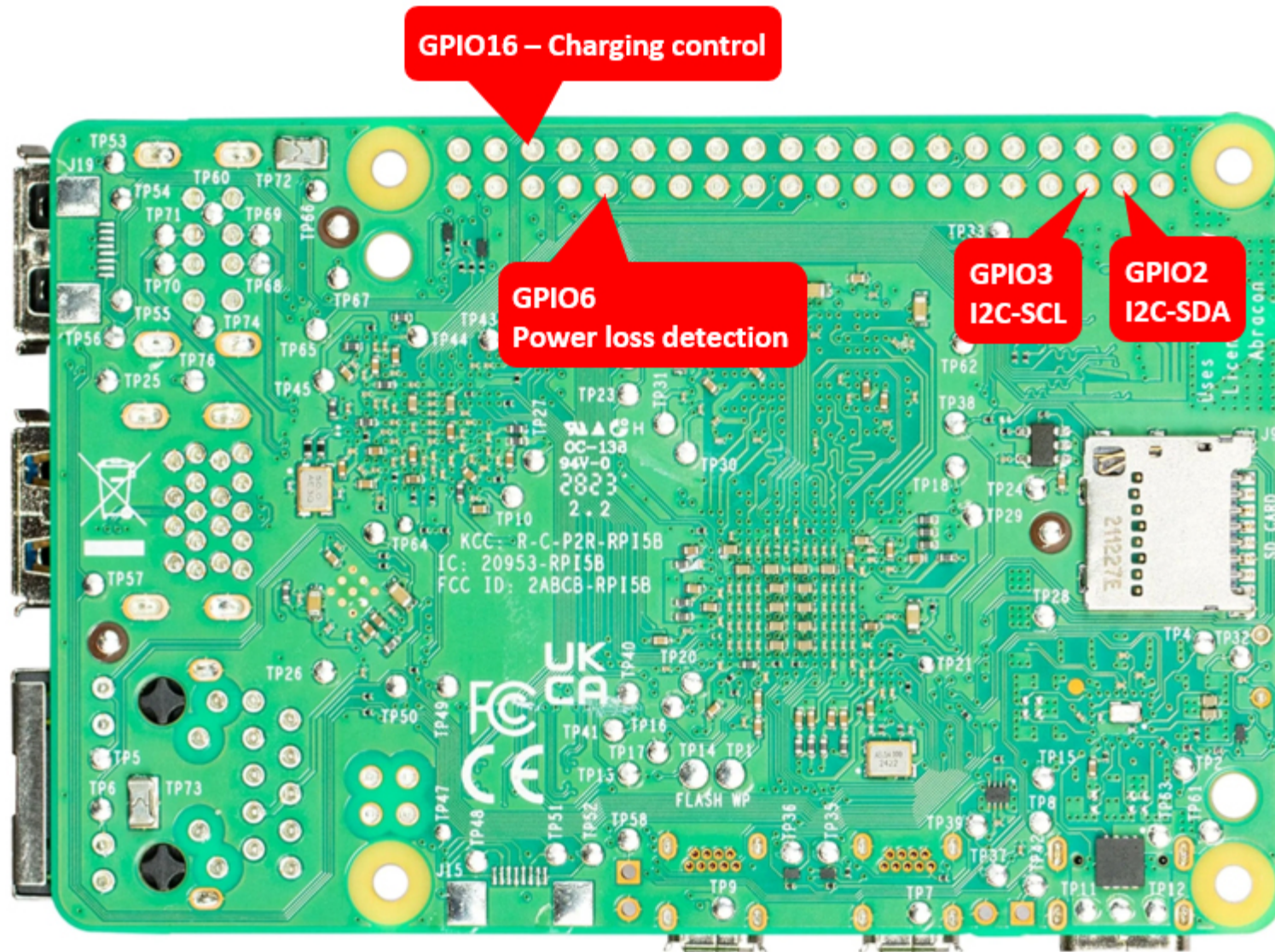

There won't be any other problems, it's this poor contact that's causing it.

